

A

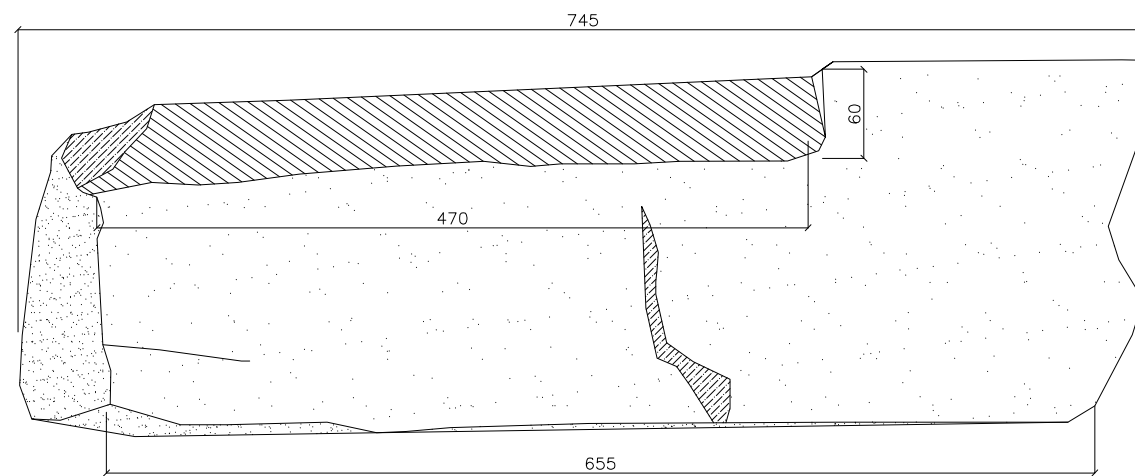

B

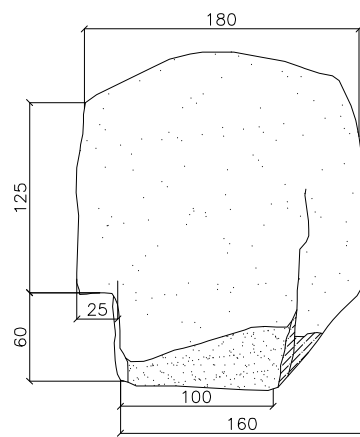

E

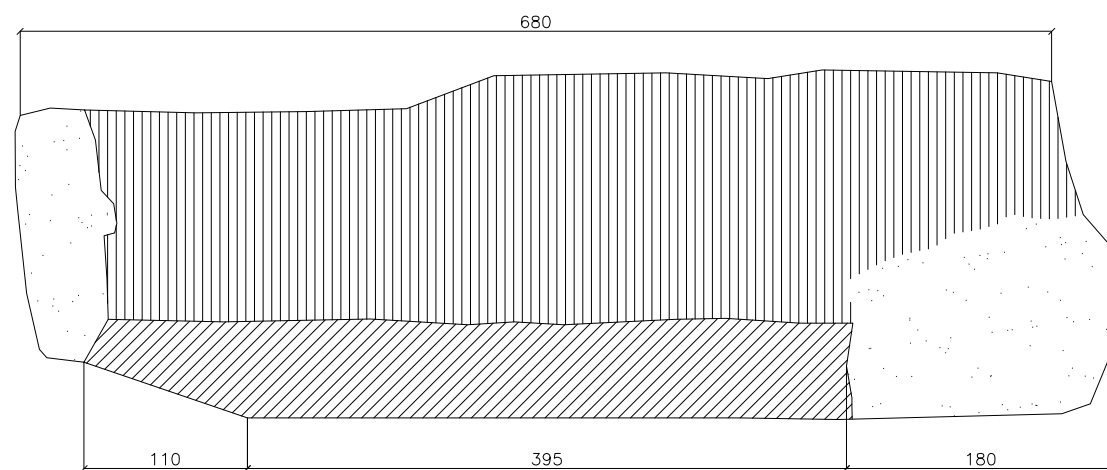

C

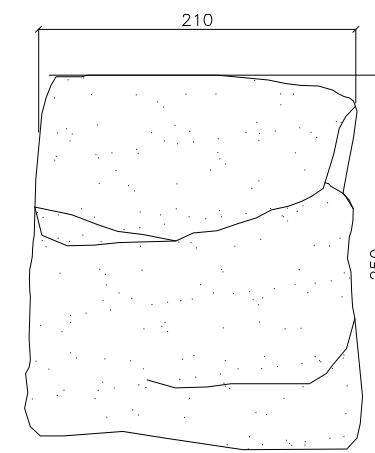

F

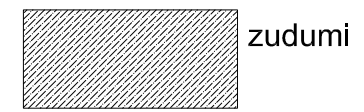

zudumi

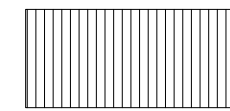

izcirstu paralēlu līniju faktūra materiālā (līniju virziens I)

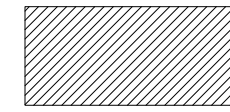

izcirstu paralēlu līniju faktūra materiālā (līniju virziens /)

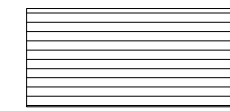

izcirstu paralēlu līniju faktūra materiālā (līniju virziens —)

Gludas plaknes bez profila vai/un dekoratīvās apdares nav attēlotas

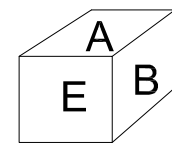
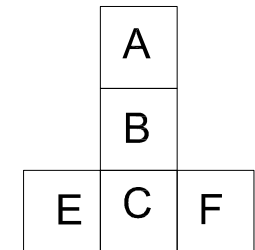

05.2021

PASŪTĪTĀJS	CĒSIS	OBJEKTS	STADIJA	AMI	ARTŪRS LAPINŠ ARHITEKTS WWW.ARTURSLAPINS.LV IERIKU IELA 43-50, RĪGA ARHĪVA NR. LAPA(S)
UZMĒRĪJA	IEVA MARTA	LOGA DETALAS FRAGMENTS UZ-2021-12	MARKA	UZ	
IZSTRĀDĀJA	IEVA MARTA		MĒROGS	1:5	
			PAS.NR.	1 IZM.	